

**NOTICE DE MONTAGE
ASSEMBLING INSTRUCTIONS
ISTRUZIONI DI MONTAGGIO
MONTAGEANLEITUNG
ISTRUCOES DE MONTAGEM
MANUAL DE MONTAJE
UPUTE O MONTAŽ**

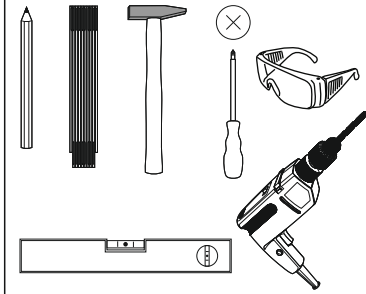

60 MIN



**ALICANTE
ATCT03**

635002

Version: 27.07.2022

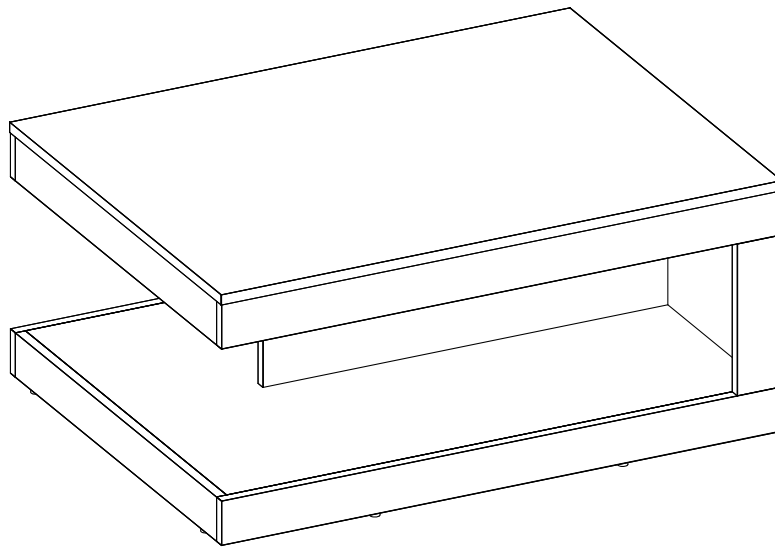

*AVANT DE COMMENCER, SE
REPORTER AUX CONSEILS
DE MONTAGE EN ANNEXE*

**BEFORE STARTING, REFER
TO THE ASSEMBLING ADVICE
IN ANNEX**

*VOR DER MONTAGE,
BEILIEGENDE ANWEISUNGEN
BEFOLGEN.*

**PRIMA DI COMINCIARE LEGGETE
LE ISTRUZIONI DI MONTAGGIO**

*ANTES DE COMERCAR, ADIAR
SE AOS CONSELHOS DE
MONTAGEM EM ANEXO*

**ANTES DE EMPEZAR
CONSULTE LOS CONSEJOS
PARA EL MONTAJE**

**PRIJE POČETKA MONTAŽE
MOLIMO PAŽLJIVO
PROČITAJTE UPUTE ZA
MONTAŽU**

**BASLAMADAN ÖNCE,
EKTEKI MONTAJ TALIMATLARINI
İNCELEYİNİZ**

**PRE POČETKA MONTAŽE MOLIMO
PAŽLJIVO PROČITAJTE UPUTSTVO
ZA MONTAŽU**

FRANCE

CODE INFORMATIQUE	

SWITZERLAND

CODE INFORMATIQUE	
INFORMATIK CODE	
CODICE INFORMATICO	

ESPANA

CODIGO INFORMATICO	

Türkiye

BİLGISAYAR KODU	

PORTUGAL

CODEGO INFORMATICO	

ITALIA

CODICE INFORMATICO	









HRVATSKA

KOD	635002

SRBIJA

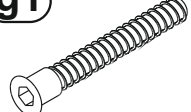
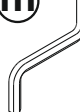
ŠIFRA ARTIKLA	635002



NOTICE DE MONTAGE
ASSEMBLING INSTRUCTIONS
ISTRUZIONI DI MONTAGGIO
MONTAGEANLEITUNG
ISTRUCOES DE MONTAGEM
MANUAL DE MONTAJE
UPUTE O MONTAŽ

 a1 8x35 x....(x38)	 a2 8x45 x...(x8)	 e0 x...(x17)	 e1 x...(x29)	 f1 x...(x29)	 g1 7x50 x...(x3)	 m x....(x1)	 n2 3,5x16 x....(x6)	 o2 x...(x11)	 w x...(x3)
--	--	---	---	---	--	---	---	---	---

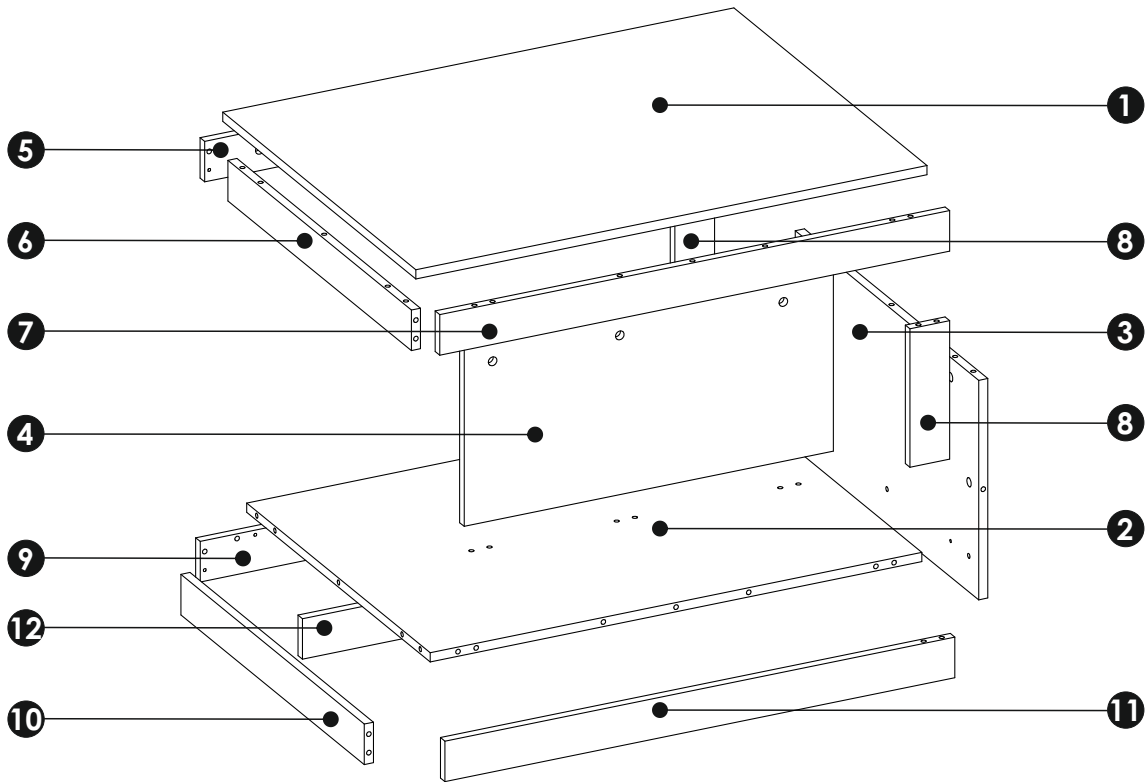
NOTICE DE MONTAGE
ASSEMBLING INSTRUCTIONS
ISTRUZIONI DI MONTAGGIO
MONTAGEANLEITUNG
ISTRUCOES DE MONTAGEM
MANUAL DE MONTAJE
UPUTE O MONTAŽ



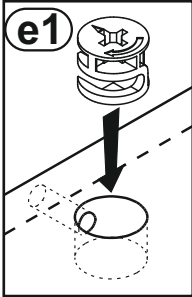
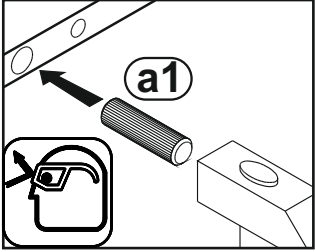
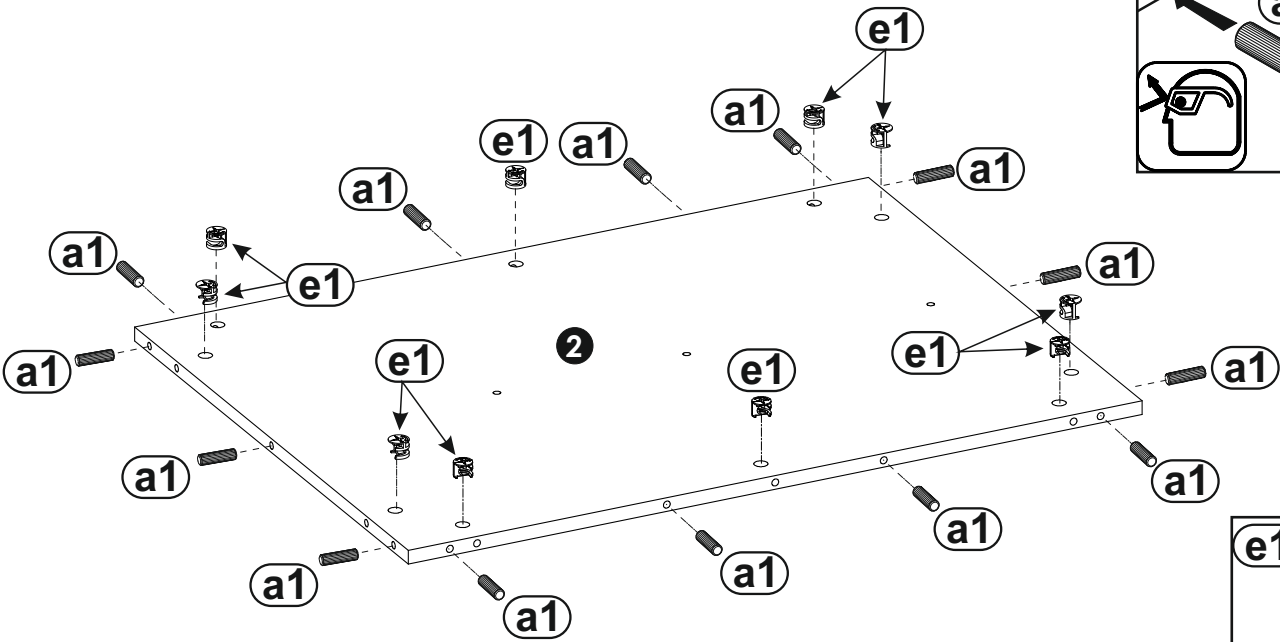

1	900	680	16 x1	1/1
2	866	646	16 x1	1/1
3	650	309	16 x1	1/1
4	646	379	16 x1	1/1
5	898	70	16 x1	1/1
6	646	70	16 x1	1/1
7	898	70	16 x1	1/1
8	239	70	16 x2	1/1
9	898	70	16 x1	1/1
10	646	70	16 x1	1/1
11	898	70	16 x1	1/1
12	866	54	16 x1	1/1

1	a1	e1
	 8x35 x14	 x10

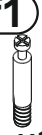

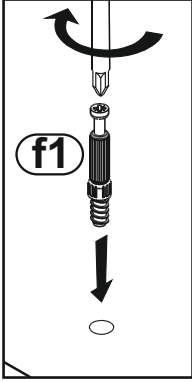
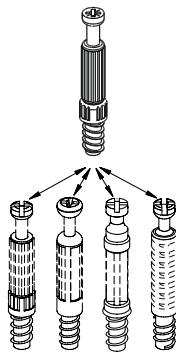
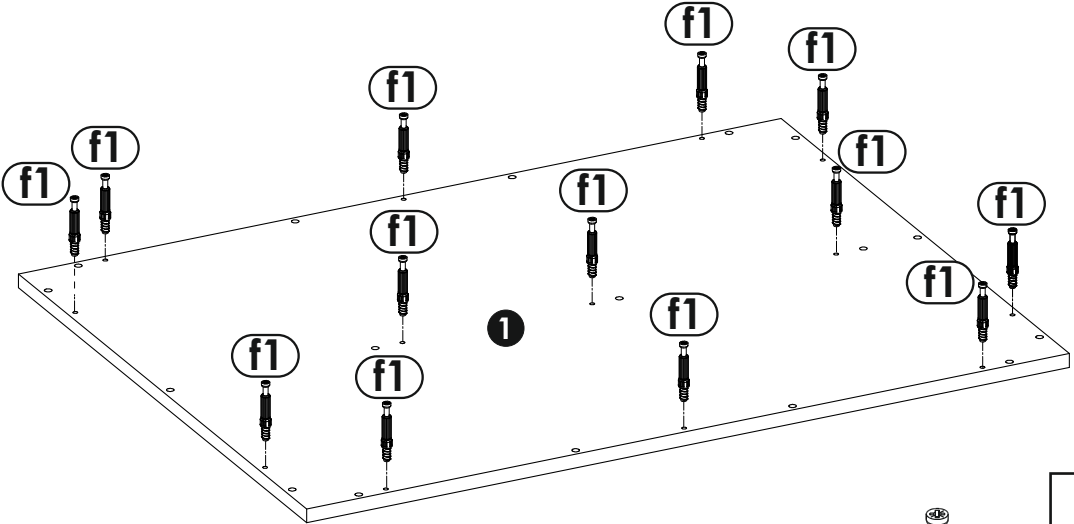

2	f1
	 x13



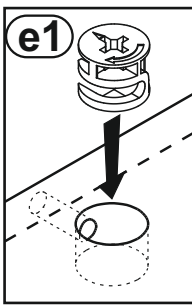
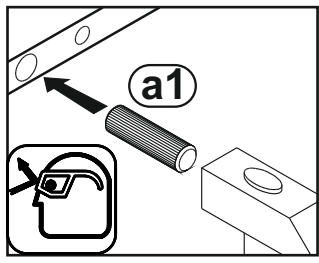
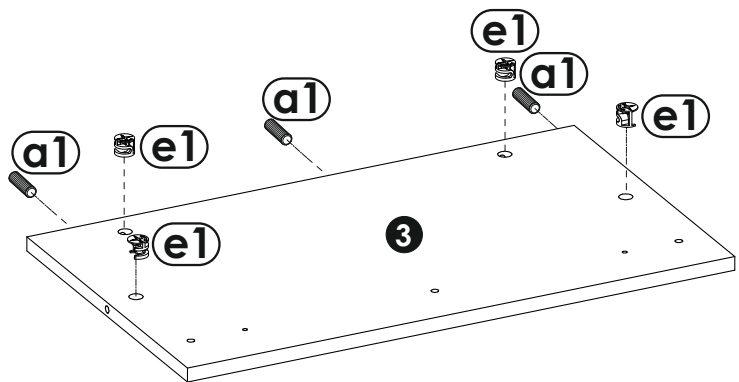

3	a1  8x35 x3	e1  x4
----------	--	--

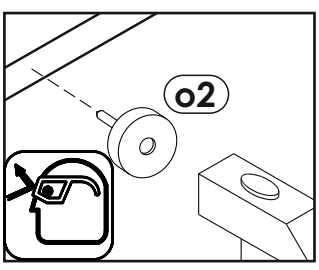
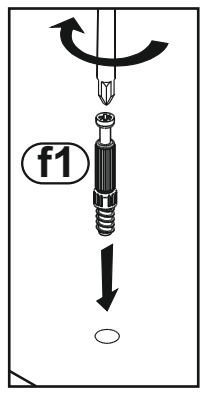
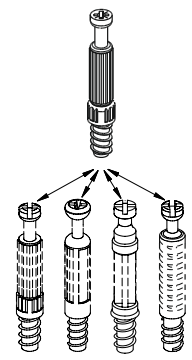
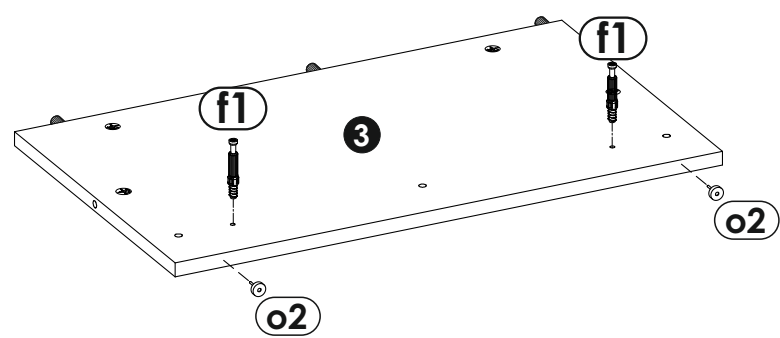

4	f1  x2	o2  x2
----------	--	--



5	a1	e1
	 8x35 x6	 x3

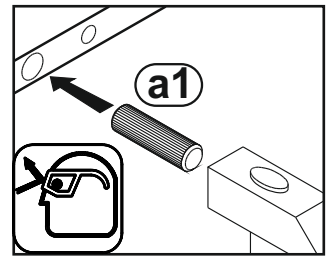
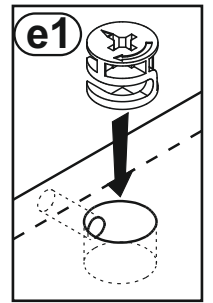
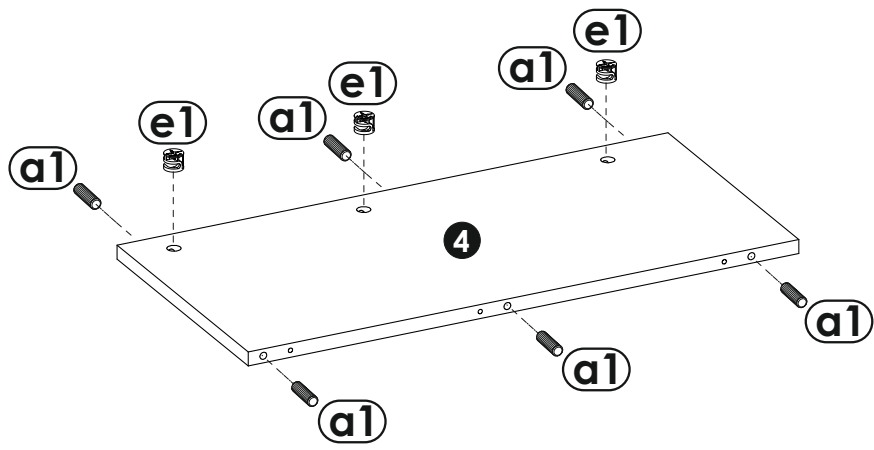

6	f1
	 x1

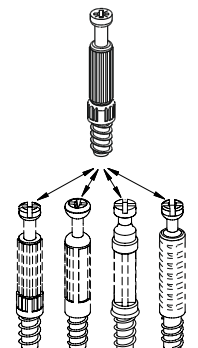
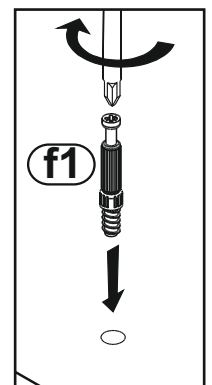
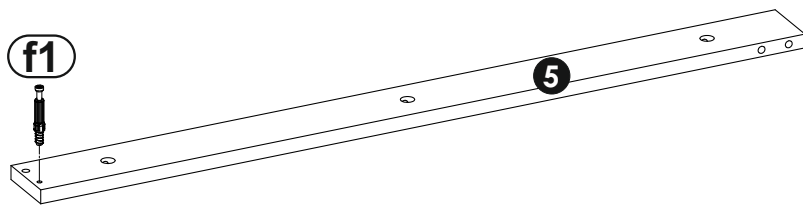

7	a1 8x35 x4	e1 x3
----------	-------------------------	-----------------

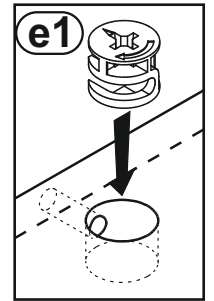
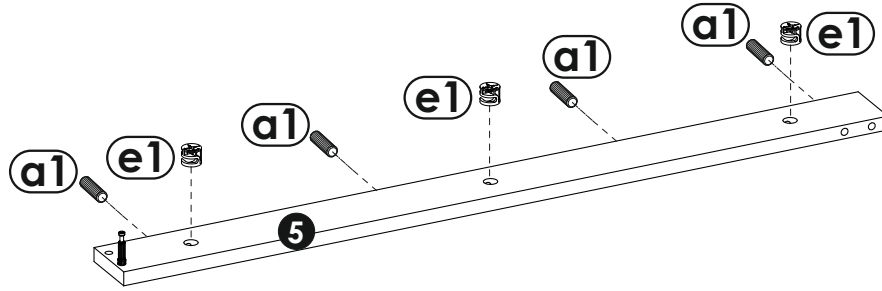
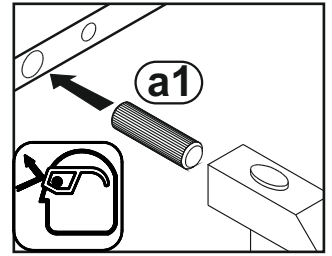

8	a1 8x35 x5	e1 x4
----------	-------------------------	-----------------

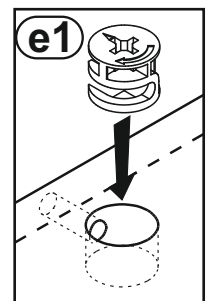
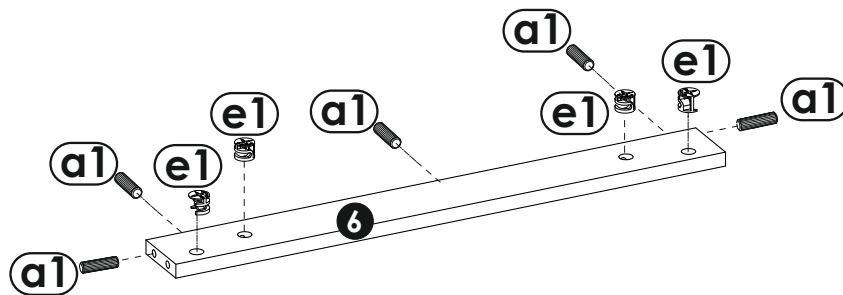
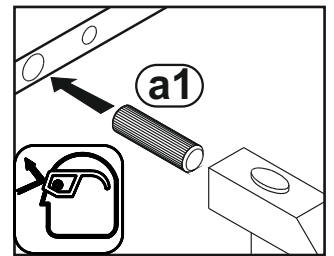

9

f1



x1

P8/21

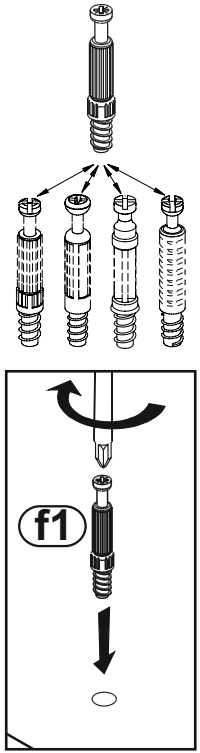
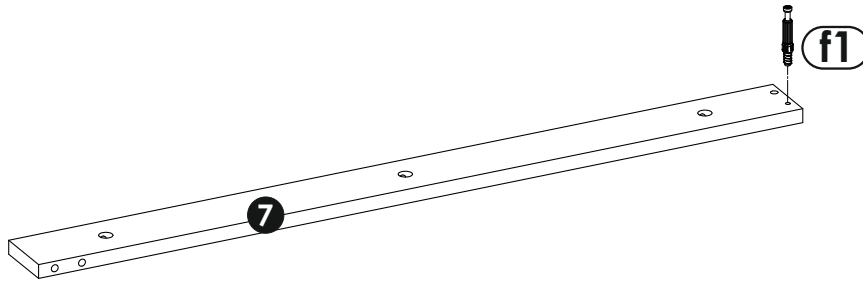

10

a1



8x35
x4

e1



x3

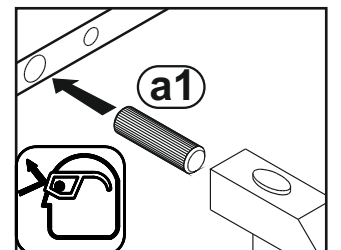
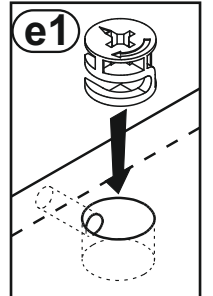
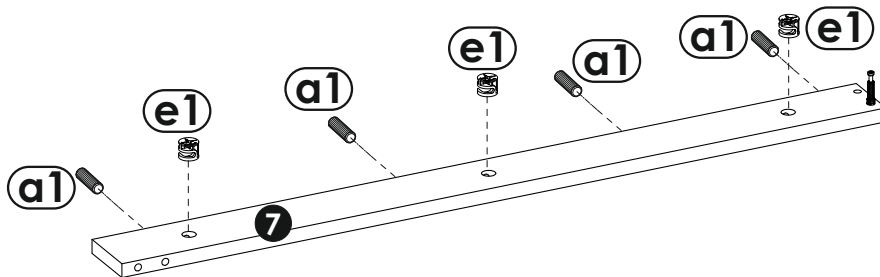

11

f1

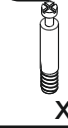

x4

o2



x2

P9/21

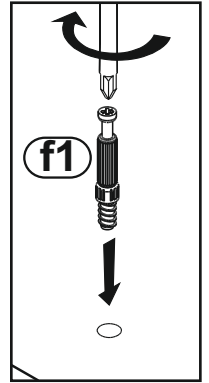
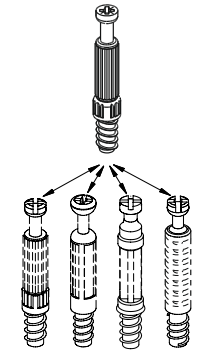
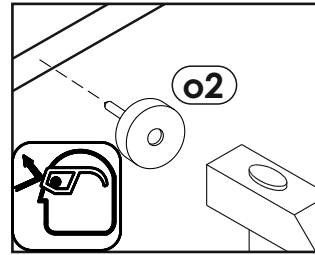
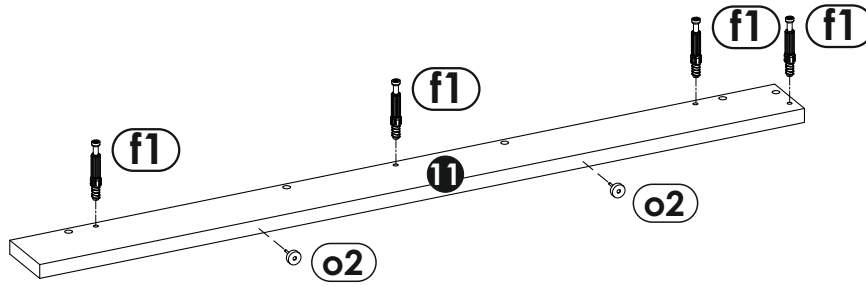

12

f1

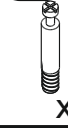

x2

o2



x2

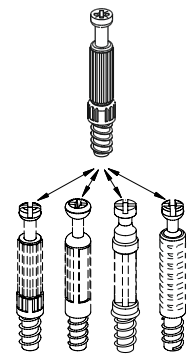
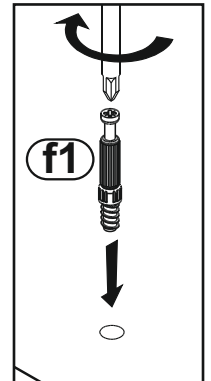
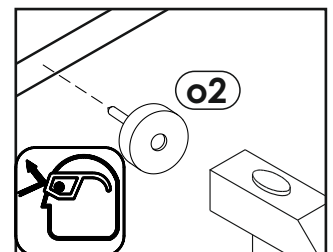
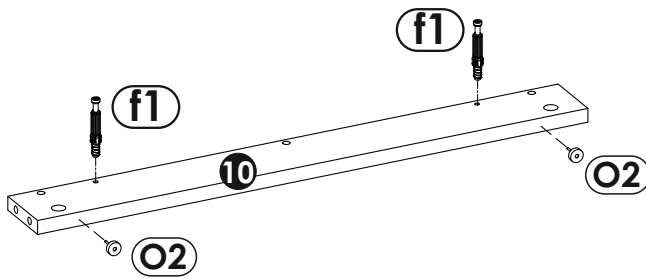

13

a1



8x35
x2

e1



x2

P10/21

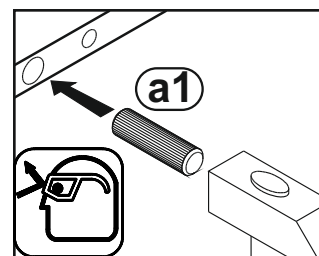
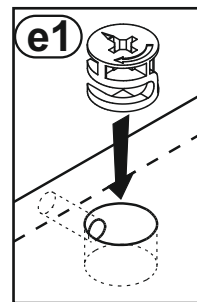
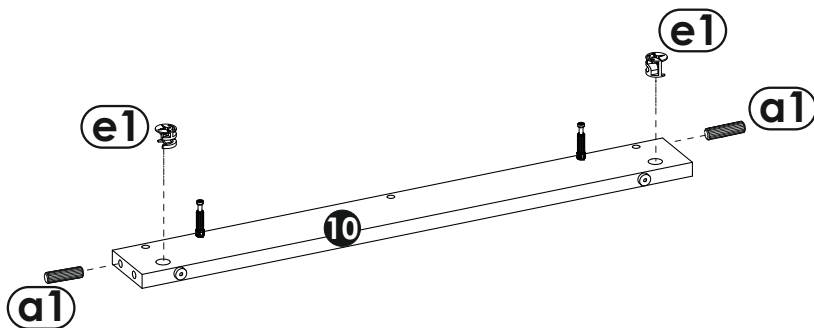

14

f1



x4

o2



x2

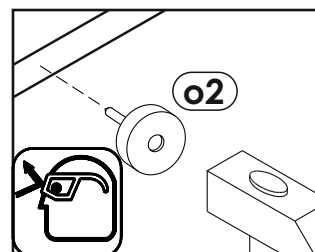
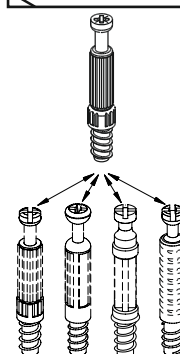
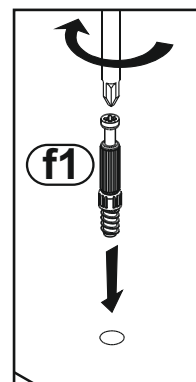
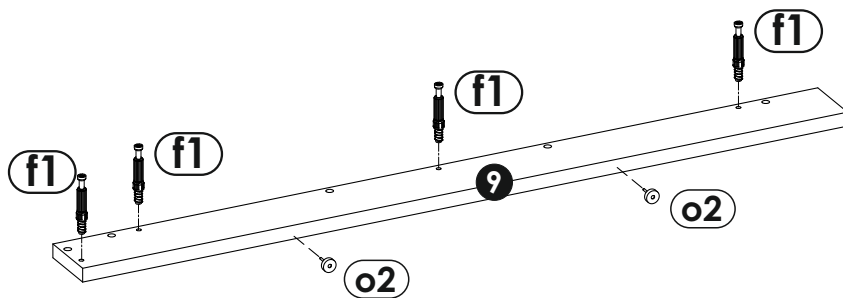

15

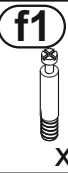

P11/21

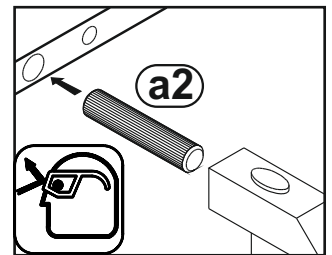
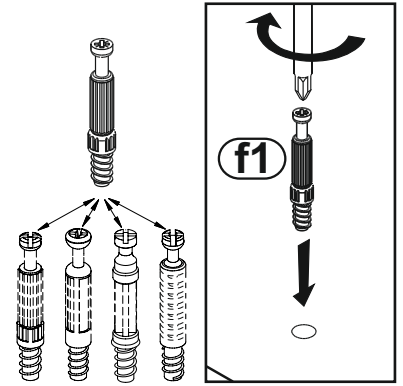
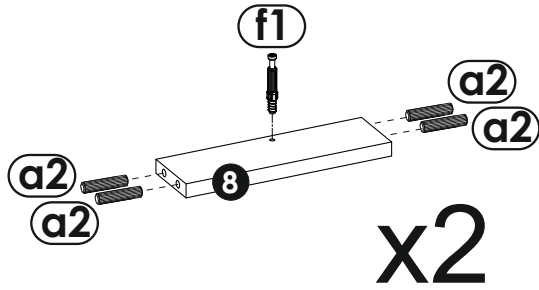

16

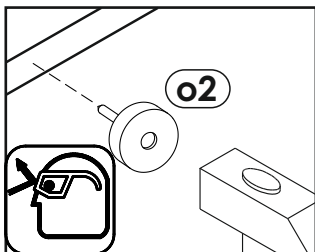
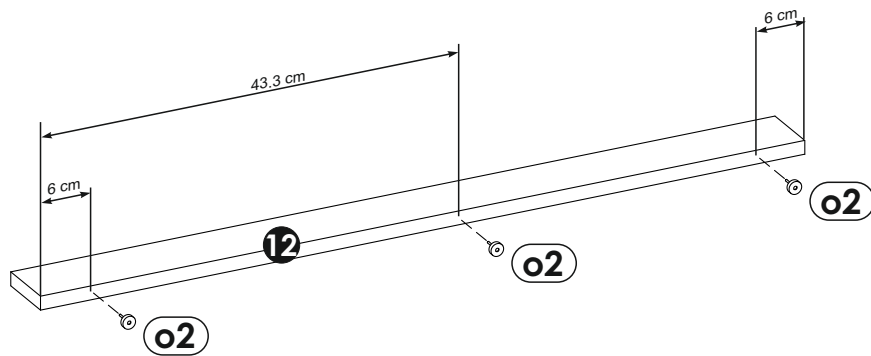
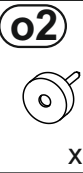

17

P12/21

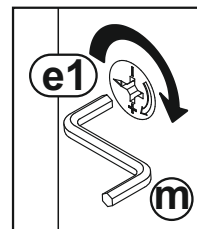
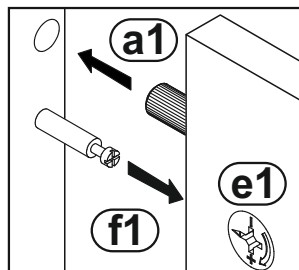
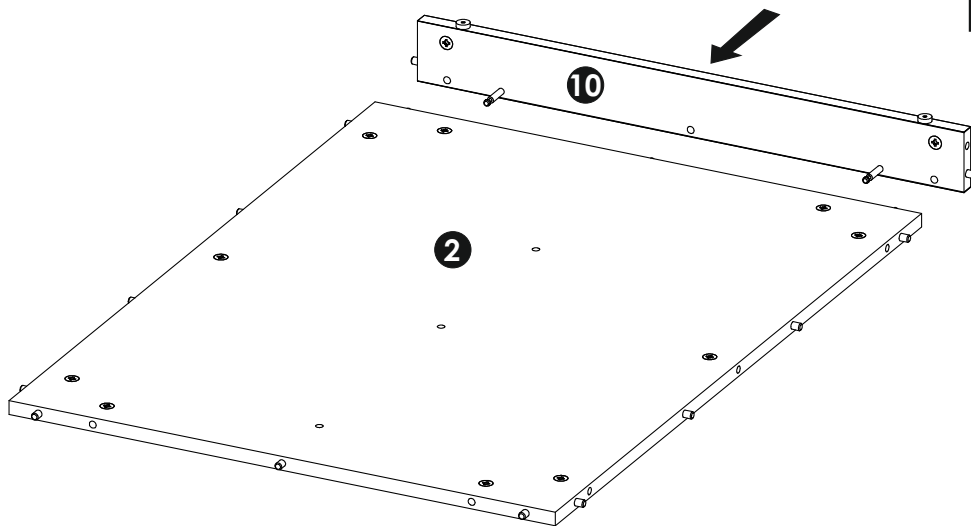

18

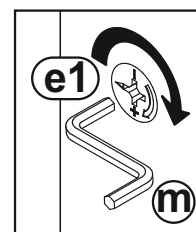
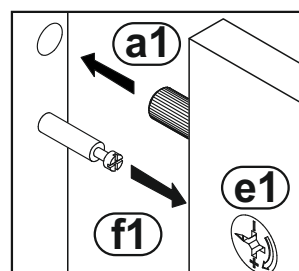
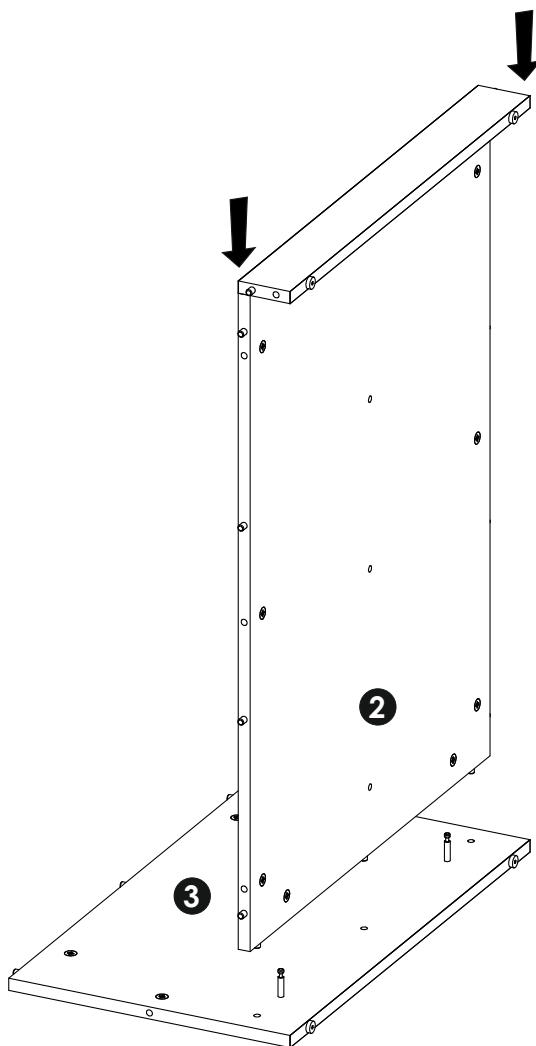

19

g1

7x50

x3

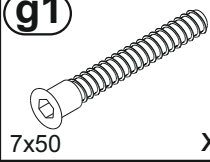

P13/21

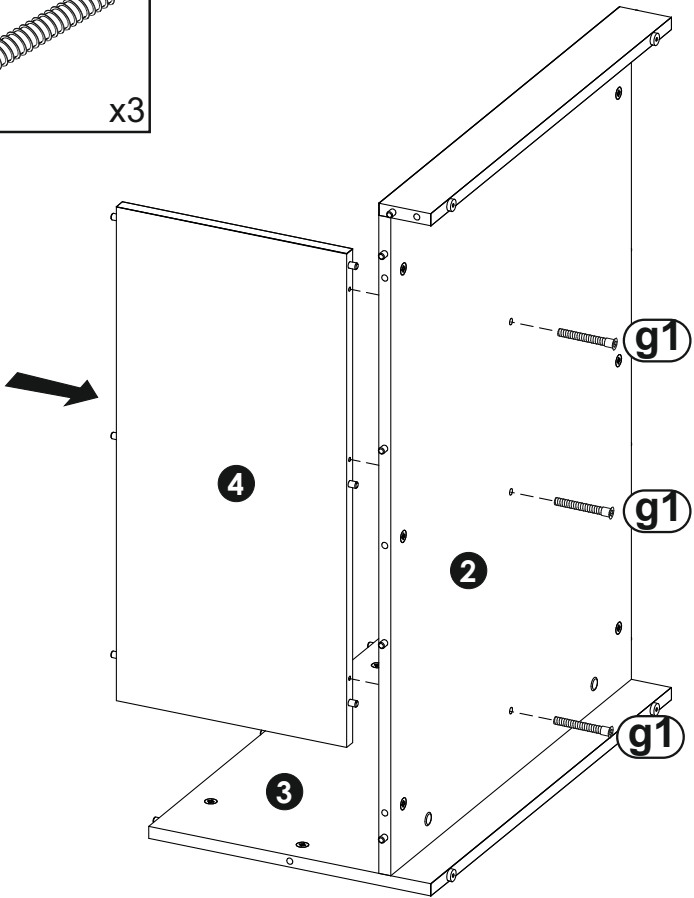
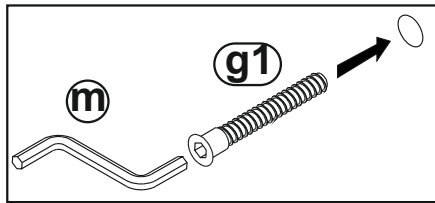

20

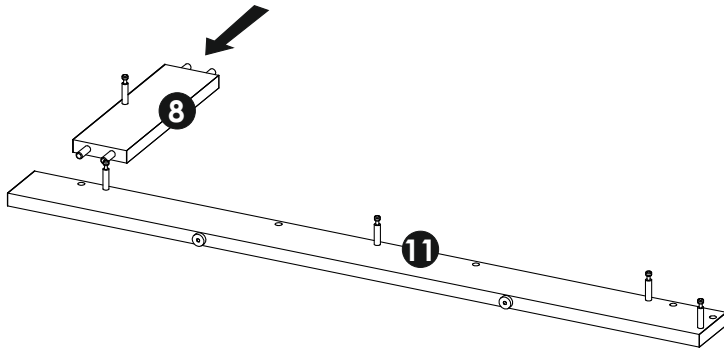

21

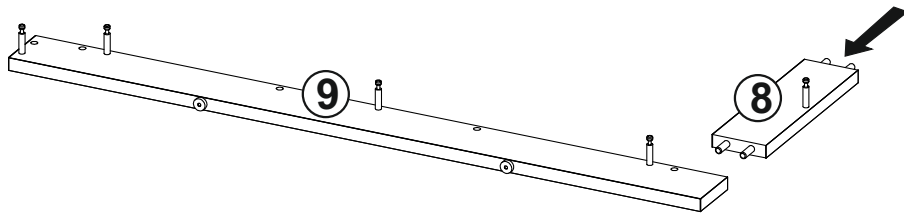

22 **e0**
x1

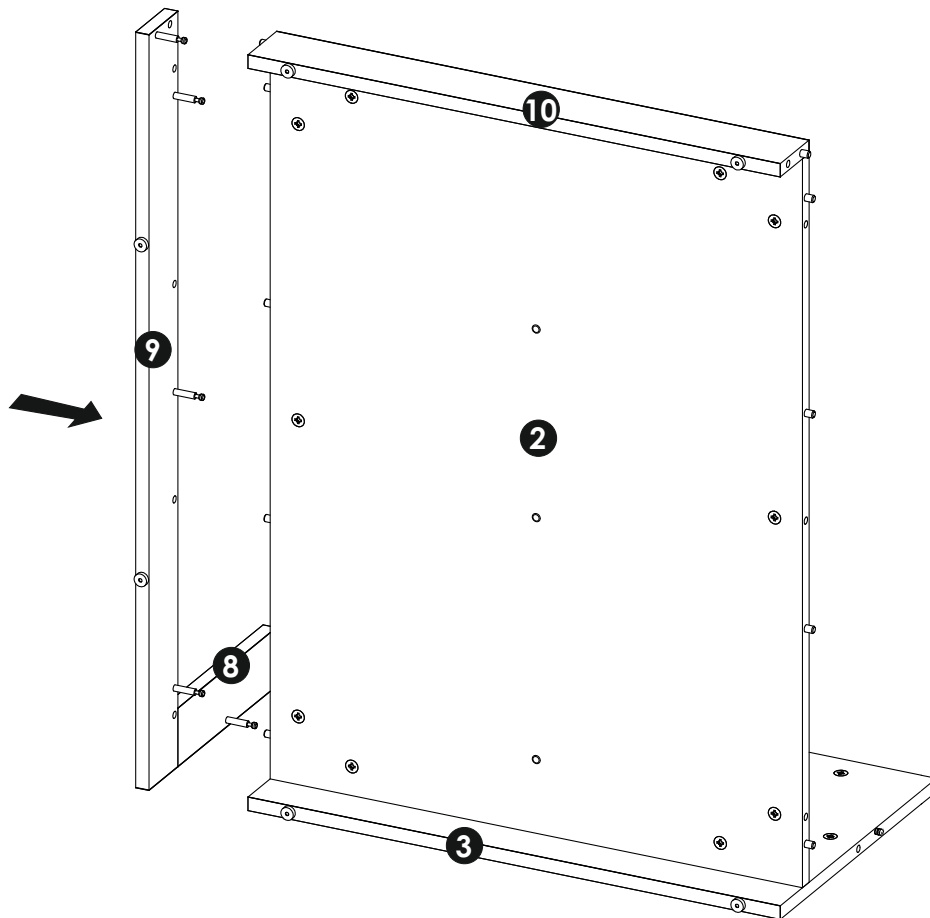
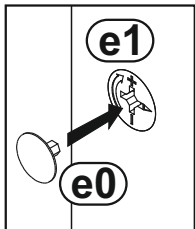
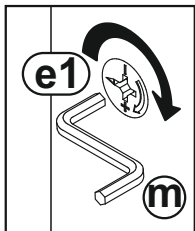
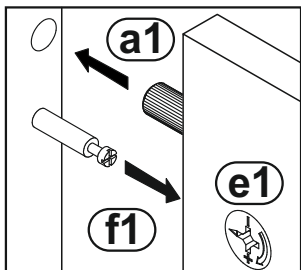

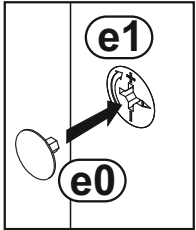
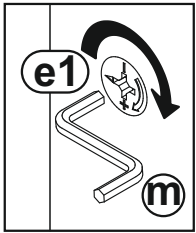
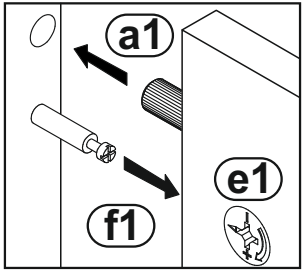
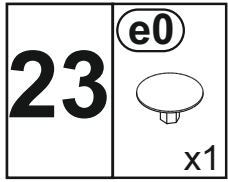

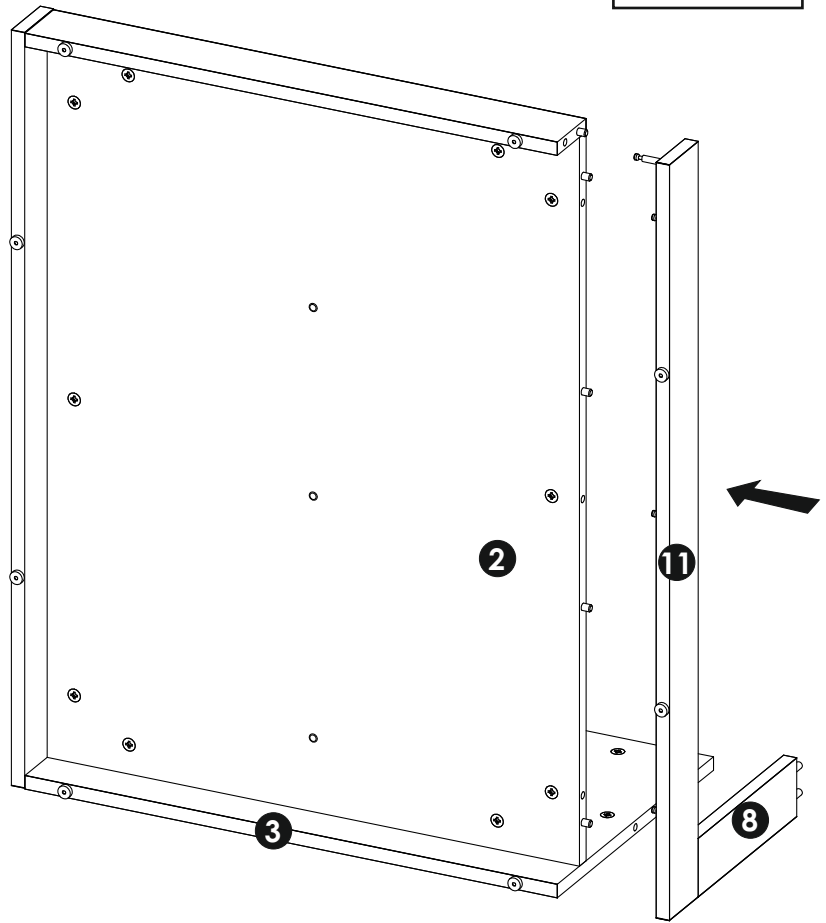

P15/21

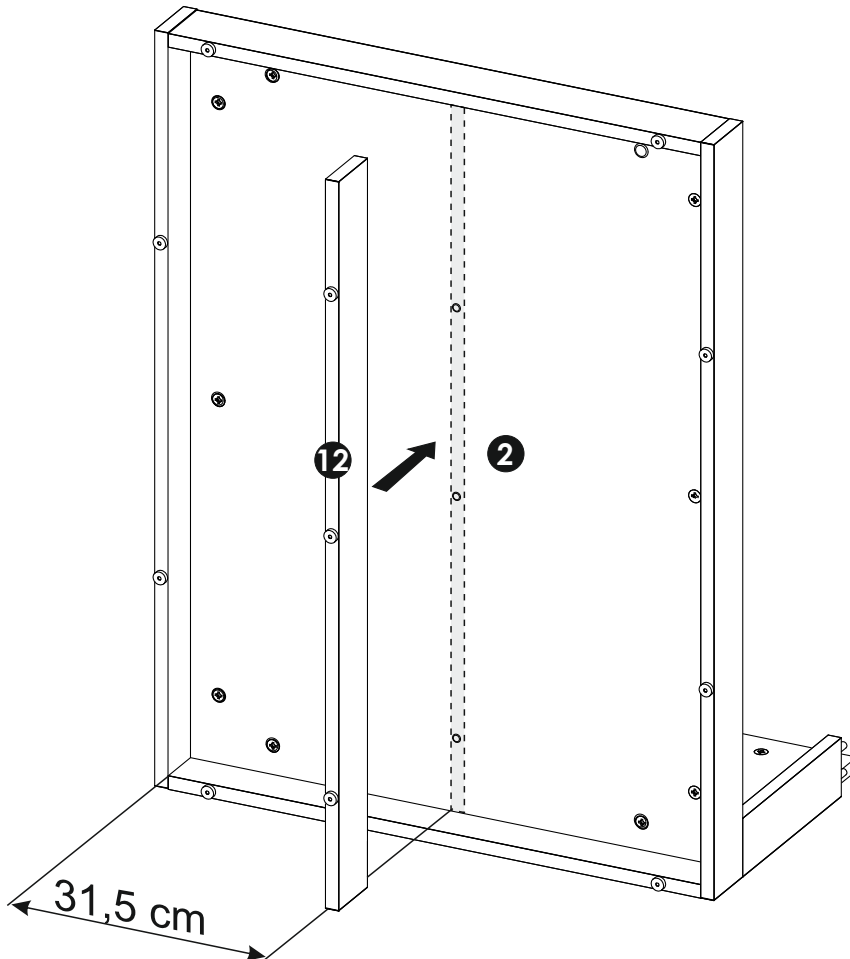

24



25	n2	w
	3,5x16  x6	 x3

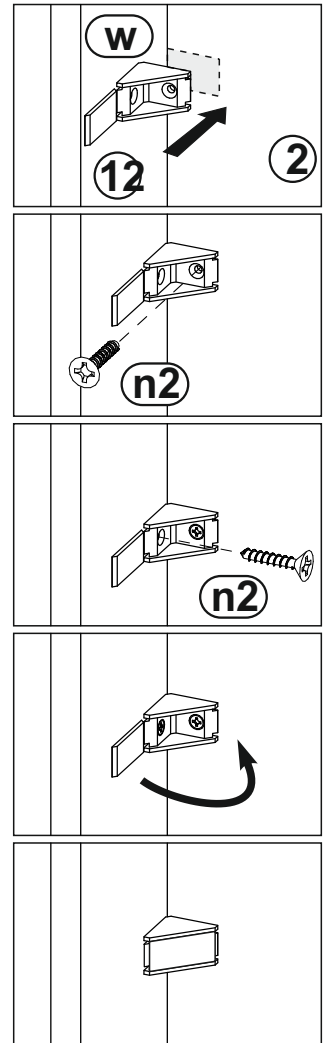
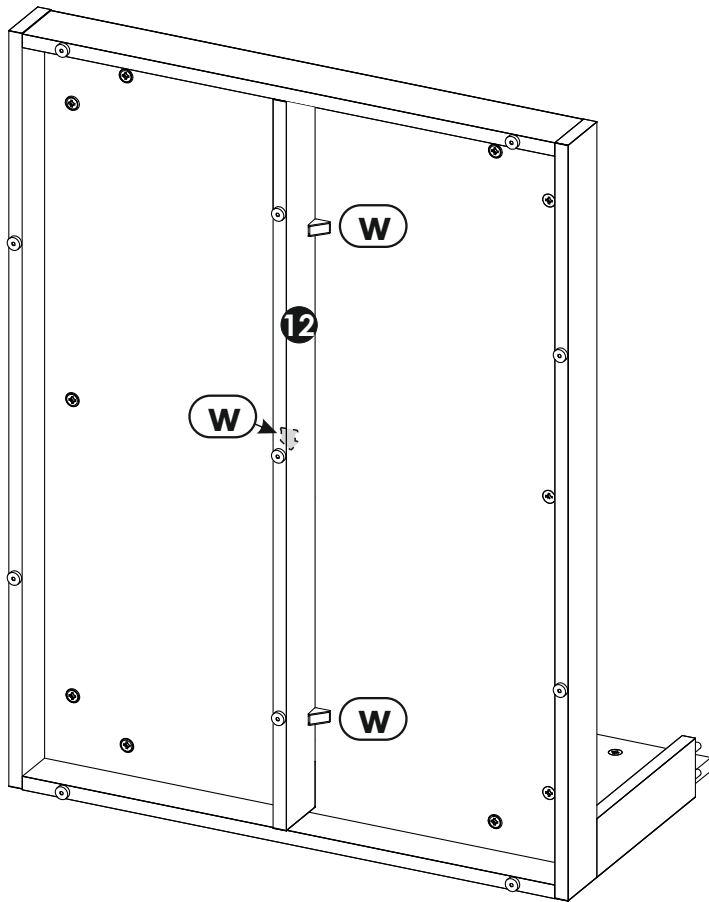

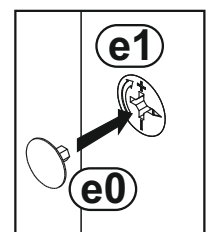
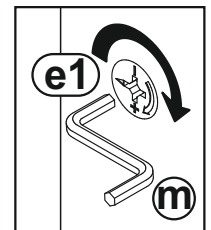
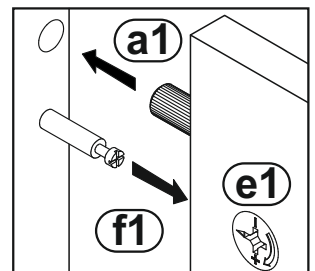
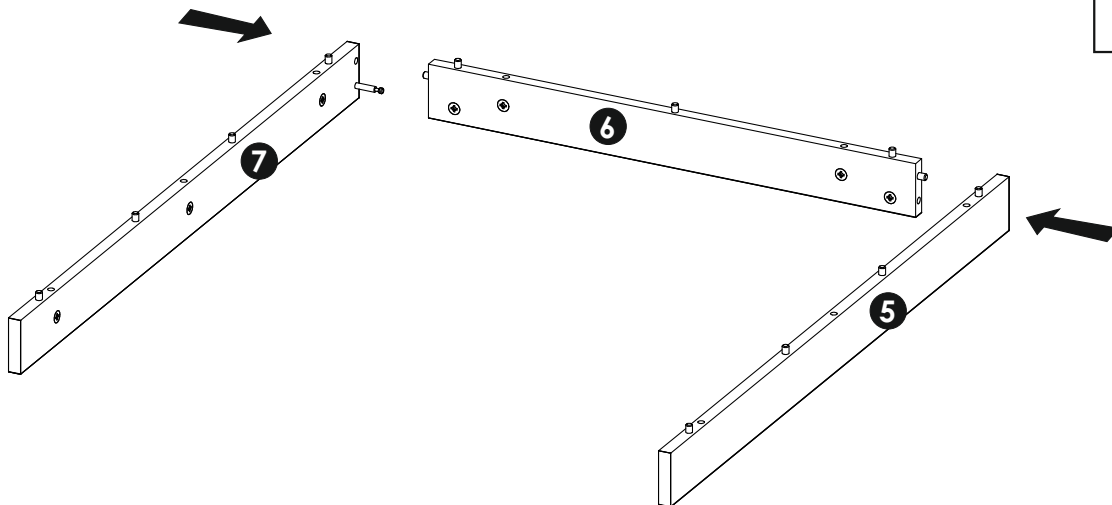

26	e0
	 x2

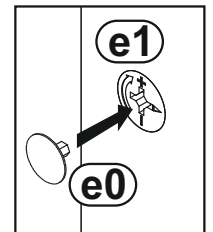
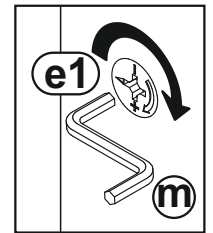
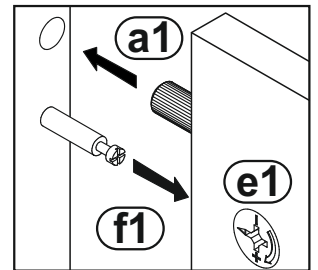
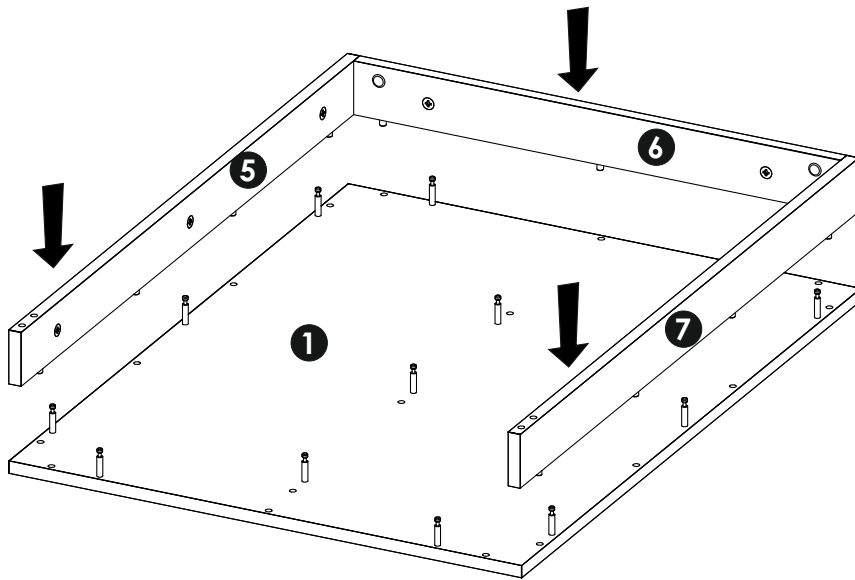

27 **e0**

x8

P17/21

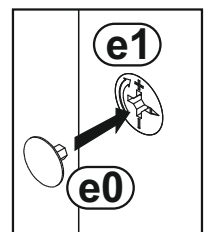
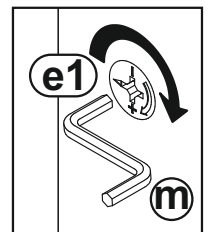
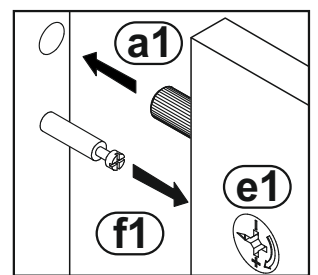
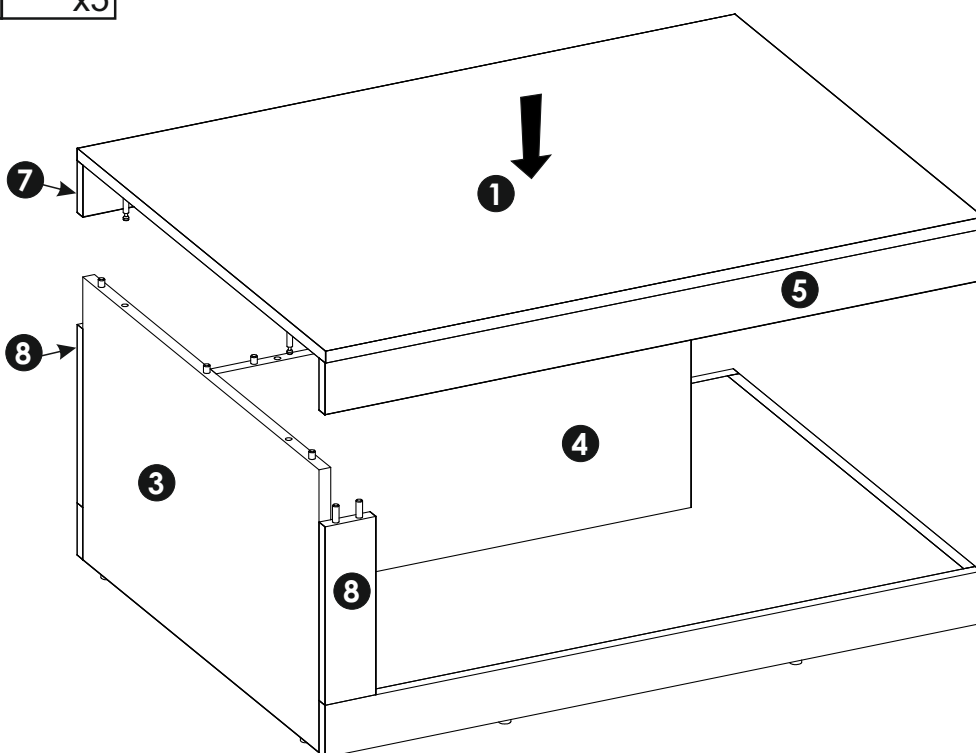

28 **e0**

x5



 max
30kg

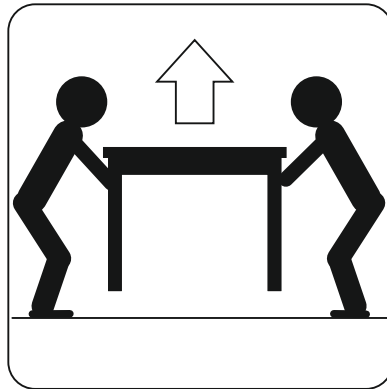
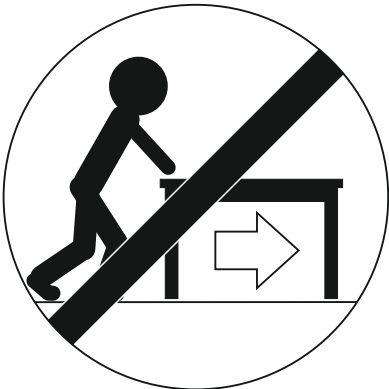
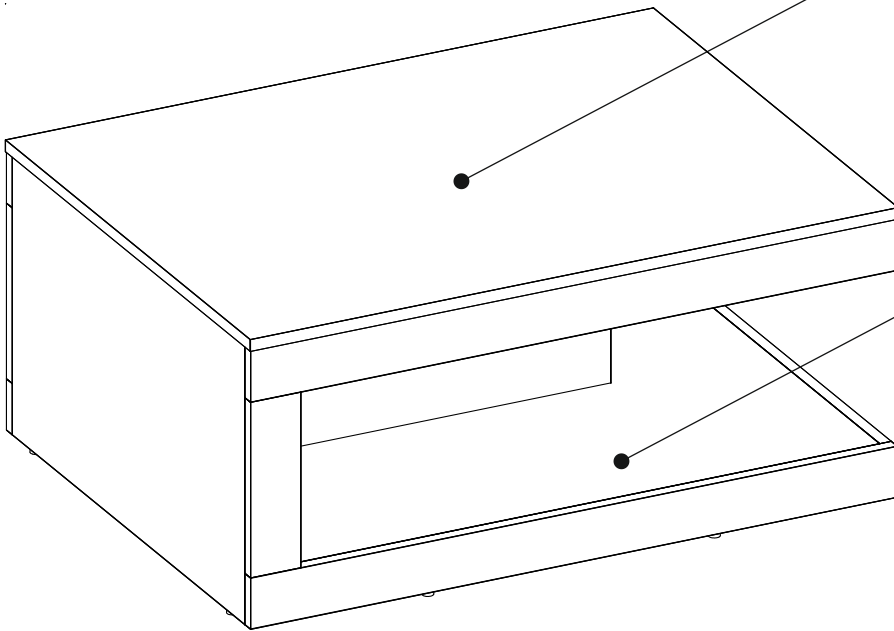

 max
15kg



FRANCAIS - SUISSE

CONSEILS DE MONTAGE :

- 1 > BIEN ETUDIER LA NOTICE DE MONTAGE.
- 2 > REPEREZ LES PIÈCES CONSTITUANT VOTRE MEUBLE.
- 3 > REGROUPEZ ET CONTRÔLEZ LA QUINCAILLERIE.
- 4 > MUNISSEZ-VOUS DE L'OUTILLAGE NECESSAIRE.
- 5 > AMENAGEZ-VOUS UNE ZONE DE MONTAGE.
- 6 > PROCEDEZ AU MONTAGE.



NE JAMAIS FORCER LES ASSEMBLAGES. RESERRER LES VIS APRES QUELQUES TEMPS D'USAGE. GARDER VOTRE NOTICE DE MONTAGE, SI UNE PIÈCE VENAIT A MANQUER, ELLE SERAIT LE PLUS CLAIR MOYEN DE COMMUNIQUER AVEC VOTRE MAGASIN.

CONSEILS D'ENTRETIEN :

- 1 > DÉPOUSSIÉREZ SOIGNEUSEMENT.
- 2 > HUMECTER UN CHIFFON DOUX ET PROPRE D'EAU LÉGÈREMENT SAVONNEUSE (OU DÉTERGENT).



- NE JAMAIS UTILISER DE PRODUITS ABRASIFS: POUDRE, LAINE D'ACIER, SOLVANTS. - NE PAS MOILLER TROP COIEUSEMENT.

	PAPIER DECOR	SURFACES STRATIFIÉES	SURFACES LAQUEES	BOIS VERNIS	TEXTILE CUIR
EAU SAVONNEUSE (SAVON NEUTRE)	○	○	○	○	○
EAU ADDITIONNÉE		○	○		
ENTRETIEN SPÉCIFIQUE FABRICANT					○

DEUTSCH - SCHWEIZ

MONTAGE ANLEITUNG:

- 1 > DIE MONTAGEANLEITUNG SORGFÄLTIG DURCHLESEN.
- 2 > DIE EINZELTEILE DES MÖBELSTÜCKS ERMITTELN.
- 3 > DIE BESCHLÄGE ZUSAMMENLEGEN UND PRÜFEN.
- 4 > DAS NOTWENDIGE WERKZEUG ZURECHTLEGEN.
- 5 > EINEN MONTAGEBEREICH FREIMACHEN.
- 6 > DAS MÖBELSTÜCK ZUSAMMENBAUEN.



NIEMALS DIE VERBINDUNGEN ZU STARK ANZIEHEN. DIE SCHRAUBEN NACH EINIGER ZEIT DES GEBRAUCHS ERNEUT FESTZIEHEN. DIE MONTAGEANLEITUNG GUT AUFBEWAHREN: SOLLTE EIN TEIL FEHLEN, IST SIE DAS BESTE VERSTÄNDIGUNGSMITTEL MIT IHREM GESCHÄFT.

PFLEGEHINWEISE :

- 1 > SORGFÄLTIG ENTSTAUBEN.
- 2 > MIT EINEM WEICHEN, SAUBEREN UND FEUCHTEM TUCH UND LEICHTER SELFENTAUGE REINIGEN.



- BENUTZEN SIE KEINE SCHEUERMITTEL WIE PULVER, STAHLWOLLE, LÖSUNGSMITTEL. - NICHT ZU NASS ABWLSCHEN.

	DEKORPAPIER	OBERFLÄCHE LAMINAT	OBERFLÄCHE LACK	LACKIERTEM HOLZ	TEXTIL LEDER
SEIFENLAUGE (NEUTRALSEIFE)	○	○	○	○	○
WASSER MIT HAUSHALTSRFINIGER		○	○		
PRODUZENT SPEZIFISCHER UNTERHALT					○

ITALIANO - SVIZZERA

CONSIGLI DI MONTAGGIO

- 1 > STUDIARE BENE LE ISTRUZIONI DI MONTAGGIO.
- 2 > PRENDERE CONOSCENZA DEI PEZZI CHE COSTITUISCONO IL MOBILE.
- 3 > RAGGRUPPARE E CONTROLLARE LA FERRAMENTA.
- 4 > MUNIRSI DEGLI UTENSILI NECESSARI.
- 5 > PREPARARE UNA ZONA DI MONTAGGIO.
- 6 > PROCEDERE AL MONTAGGIO.



NON FORZARE MAI GLI ASSEMBLAGGI. RESTRINGERE LE VITI DOPO UN PERIODO D'UTILIZZO. CONSERVARE QUESTE ISTRUZIONI DI MONTAGGIO, POICHE', SE UN PEZZO DOVESSE MANCARE, ESSE SAREBBERO IL MIGLIORE MEZZO DI COMUNICAZIONE CON IL RIVENDITORE

CONSIGLI PER LA MANUTENZIONE :

- 1 > SPOLVERATE ACCURATAMENTE.
- 2 > INUMIDIRE CON ACQUA LEGGERMENTE INSAPONATA UNO STRACCIO MORBIDO E PULITO.



- NON UTILIZZARE MAI PRODOTTI ABRASIVI: POLVERE, LANA DI ACCIAIO, SOLVENTI. - NON BAGNARE ECCESSIVAMENTE.

	CARTA	SUPERFICI STRATIFICATE	SUPERFICI LACCATE	SUPERFICI LACCATE / LEGNO VERNICIATO	TESSILE / CUIOIO
ACQUA CON SAPONE (SAPONE NEUTRO)	○	○	○	○	○
ACQUA CON DETERSIVO		○	○		
MANUTENZIONE SPECIFICA PRODUTTORE					○

TÜRKÇE

MONTAJ TALİMATLARI:

- 1 > Montaj tanıtım yazısını dikkatlice okuyunuz.
- 2 > Mobilyanızı oluşturan parçaları işaretleyiniz.
- 3 > Hırdavatla ilgili parçaları bir araya toplayıp; kontrol ediniz.
- 4 > Gereken araç ve gereci tedarik ediniz.
- 5 > (Kendinize) Bir montaj alanı edininiz.
- 6 > Monte etmeye başlayınız.



MONTAJLARI ZORLAMAYINIZ.
BİRKAÇ KULLANIMDAN SONRA VİDALARI SIKIŞTIRINIZ.
BİR PARÇANIN KAYBOLMASI DURUMUNDA MAĞAZANIZLADAKİ
KOLAY İLETİŞİME GEÇEBİLMENİZ İÇİN MONTAJ KULLANIM
TALİMATINIZI SAKLAYINIZ.

BAKIM TALİMATLARI:

- 1 > TOZUNU DİKKATLİCE ALINIZ.
- 2 > YUMUŞAK BİR BEZİ TEMİZ SU VE AZ MİKTARDA SABUNLA(DETERJAN) NEMLENDİRİNİZ.



- ASLA AŞINDIRICI ÜRÜNLER
KULLANMAYINIZ : ÇELİK YÜNÜ,
SOLVENT...
- BOL SUYLA YIKAMAYINIZ.

	SÜS KAĞIDI	KATMAN YÜZEY	LAKE YÜZEY	ÇİRALI TAHTA	TEKSTİL DERİ
SABUNLU SU (NÖTR SABUN)	○	○	○	○	○
DETERJAN KATILMIŞ SU		○	○		
ÜRETİCİYE ÖZGÜ BAKIM					○

ENGLISH

ASSEMBLY ADVICE :

- 1 > CAREFULLY READ THE ASSEMBLY INSTRUCTION.
- 2 > IDENTIFY THE COMPONENTS OF THE FURNITURE.
- 3 > GROUP AND CHECK THE HARDWARE.
- 4 > USE THE REQUIRED TOOLS.
- 5 > CREATE AN ASSEMBLY ZONE.
- 6 > MAKE THE ASSEMBLY.



NEVER FORCE THE CONNECTIONS.
RE-TIGHTEN THE SCREWS AFTER FEW DAYS.
PLEASE RETAIN THE AI LEAFLET FOR FUTURE REFERENCE,
THE AI CONTAINS INFORMATION WHEN CLAIMING
FOR MISSING PARTS.

CLEANING ADVICE:

- 1 > CAREFULLY REMOVE THE DUST.
- 2 > USE A SOFT, CLEAN DAMP CLOTH WITH SOAPY WATER.



NEVER USE ABRASIVE PRODUCTS
OR SOLVENTS.
DO NOT APPLY EXCESSIVE PRESSURE
WHEN USING THE DAMP CLOTH.

	PAPER DECOR	LAMINATED SURFACES	LACQUERED SURFACE	VARNISHED WOOD	LEATHER TEXTILE
SOAPY WATER (NEUTRAL SOAP)	○	○	○	○	○
WATER WITH DETERGENT		○	○		
SPECIFIC SUPPLIER CLEANING					○

SRBIJA

SAVETI ZA MONTAŽU:

1. PAŽLJIVO PROČITAJTE UPUTSTVA ZA MONTAŽU
2. PROVERITE DA LI IMATE SVE DELOVE
3. SAKUPITE I PROVERITE OKOVE ZA MONTAŽU
4. PRIPREMITE POTREBAN ALAT
5. PRIPREMITE PROSTOR ZA MONTAŽU
6. POČNITE DA MONTIRATE
7. SAČUVAJTE OVA UPUTSTVA
8. PROIZVOD JE NAMENJEN ISKLJUČIVO ZA KUĆNU UPOTREBU



NEMOJTE UPOTREBLJAVATI SILU PRILIKOM SKLAPANJA, NAKON
NEKOG VREMENA PONOVO PRITEGNITE ŠRAFOVE, ČUVAJTE
UPUTSTVA ZA MONTAŽU, U SLUČAJU NEDOSTATAKA NEKOG DELA
NAJBOLJE DA KONTAKTIRATE PRODAJNO MESTO.

UPUTSTVA ZA ODRŽAVANJE:

1. PAŽLJIVO OBRISATI PRAŠINU
2. PREBRISATI ČISTOM, MEKOM TKANINOM NAVLAŽENOM U BLAGOM RASTVORU SAPUNA ILI DETERDŽENTA



ZABRANJENA UPOTREBA HEMIKALIJA ILI BILO KAKVIH
POMOĆNIH SREDSTAVA ZA RIBANJE, JAKIH
SREDSTAVA ZA ČIŠĆENJE ILI ČELIČNE ŽICE.
ZABRANJENO ČIŠĆENJE SA PREVIŠE VODE/VLAGE.

	HARTIJA	LAMINAT	LAK	DRVO	TEKSTIL/KOŽA
RASTVOR SAPUNA	○	○	○	○	○
RASTVOR DETERDŽENTA		○	○		
NAMENSKA SREDSTVA					○

PROIZVOD JE NAMENJEN ISKLJUČIVO ZA KUĆNU UPOTREBU

ESPAOL

CONSEJOS PARA EL MONTAJE:

- 1 > ESTUDIE ATENTAMENTE EL MANUAL DE MONTAJE.
- 2 > LOCALICE LAS PIEZAS QUE CONSTITUYEN SU MUEBLE.
- 3 > REUNA Y CONTROLE LOS TORNILLOS.
- 4 > EQUIPE-SE DE LAS HERRAMIENTAS NECESARIAS.
- 5 > PREPARE UNA ZONA DE MONTAJE.
- 6 > REALICE EL MONTAJE.



NO FUERCE NUNCA EN LAS UNIONES. APRIETE LOS TORNILLOS DESPUES DE CIERTO TIEMPO DE UTILIZACION CONSERVE SU MANUAL DE MONTAJE, SI FALTARA UNA PIEZA, SERIA LA MANERA MAS FACIL DE COMUNICAR CON LA TIENDA.

CONSEJOS PARA EL MANTENIMIENTO:

- 1 > DESPOLVOREAR CULDADOSAMENTE.
- 2 > HUMEDECER UN PANO SUAVE Y LIMPIO CON AGUA LIGERAMENTE ENJABONADA.



- NO USE NUNCA PRODUCTOS ABRASIVOS TALES COMO: POLVO DE LIMPIAR, LANA DE ACERO, SOLVENTES. - NO MOJAR EXAGERADAMENTE.

	PAPEL DE DECORACION	SUPERFICIE ESTRATIFICADAS	SUPERFICIE MAQUEADAS	MADERA BARNIZADA	TEXTIL CUERO
AGUA Y JABON (JABON NEUTRO)	○	○	○	○	○
AGUA COM DETERGENTE		○	○		
MANTENIMIENTO ESPECIFICO DEL FABRICANTE					○

PORTUGUS

CONSELHOS DE MONTAGEM:

- 1 > ESTUDE BEM AS INSTRUÇÕES DE MONTAGEM.
- 2 > REUNA AS PEÇAS QUE CONSTITUEM O SEU MÓVEL.
- 3 > REAGRUBE AS FERRAGENS.
- 4 > EQUIPE-SE COM AS FERRAMENTAS NECESSÁRIAS.
- 5 > PREPARE UMA ÁREA PARA A MONTAGEM.
- 6 > INICIE A MONTAGEM.



NUNCA FORÇAR OS ENCAIXES. REAPERTAR OS PARAFUSOS APÓS UM TEMPO DE UTILIZAÇÃO. GUARDAR AS INSTRUÇÕES DE MONTAGEM. CASO FALTE ALGUMA PEÇA, O MAIS ACONSELHÁVEL É CONTATAR O REVENDEDOR.

CONSELHOS PARA A MANUTENÇÃO :

- 1 > ELIMINAR BEM O PÓ.
- 2 > UMEDECER UM PANO SUAVE E LIMPO COM ÁGUA E UM POUCO DE SABO.



- NUNCA UTILIZAR PRODUTOS ABRASIVOS: SAPONÁCEOS, L DE AÇO, SOLVENTES. - NO MOLHAR DEMASIADO.

	ACABAMENTO IMITAÇÃO	SUPERFÍCIES ESTRATIFICADAS	SUPERFÍCIES LACADAS	MADEIRA ENVERNIZADA	TEXTEIS PELES
ÁGUA COM SAB O (SABO NEUTRO)	○	○	○	○	○
ÁGUA COM DETERGENTE		○	○		
INSTRUCES ESPECÍFICAS DO FABRICANTE					○

HRVATSKA

UPUTE ZA MONTAŽU:

- 1 > PAŽLJIVO PROČITAJTE UPUTE ZA MONTAŽU.
- 2 > PRIPREMITE SVE DIJELOVE NAMJEŠTAJA.
- 3 > PRIKUPITE I PROVJERITE OKOVE ZA MONTAŽU.
- 4 > PRIPREMITE POTREBAN ALAT.
- 5 > PRIPREMITE PROSTOR ZA MONTAŽU.
- 6 > POČNITE MONTIRATI.
- 7 > SAČUVAJTE OVE UPUTE.
- 8 > PROIZVOD JE NAMJENJEN ISKLJUČIVO ZA KUĆNU UPORABU.



NEMOJTE UPOTREBLJAVATI SILU PRILIKOM SKLAPANJA NAKON NEKOG VREMENA PONOVRNO PRITEGNITE VIJKE ČUVAJTE UPUTE ZA MONTAŽU, U SLUČAJU NEDOSTATKA NEKOG DIJELA NAJBOLJE ĆE BITI DA KONTAKIRATE PRODAJNO MJESTO.

UPUTE ZA ODRŽAVANJE:

- 1 > PAŽLJIVO OBRISATI PRAŠINU.
- 2 > PREBRISATI ČISTOM, MEKOM TKANINOM NAVLAŽENOJ U BLAGOJ OTOPINI SAPUNA ILI DETERD ŽENTA.



-ZABRANJENA JE UPOTREBA KEMIKALIJA ILI BILO KAKVIH POMOĆNIH SREDSTAVA ZA RIBANJE JAKIH SREDSTAVA ZA ČIŠĆENJE ILI ČELIČNE VUNE. -ZABRANJENO JE ČIŠĆENJE SA PREVIŠE VODE/VLAGE.

	PAPIR	LAMINAT	LAK	DRVO	TEKSTIL / KOŽA
OTPINAP SAPUNA	○	○	○	○	○
OTPINAP DETERDŽENTA		○	○		
NAMJENSKA SREDSTVA					○

PROIZVOD JE NAMJENJEN ISKLJUČIVO ZA KUĆNU UPORABU!